



Châssis PEUGEOT 201

« ESSIEU RIGIDE »

Plans
&
Cotations dimensionnelles





Châssis PEUGEOT 201

Essieu rigide

Nomenclature

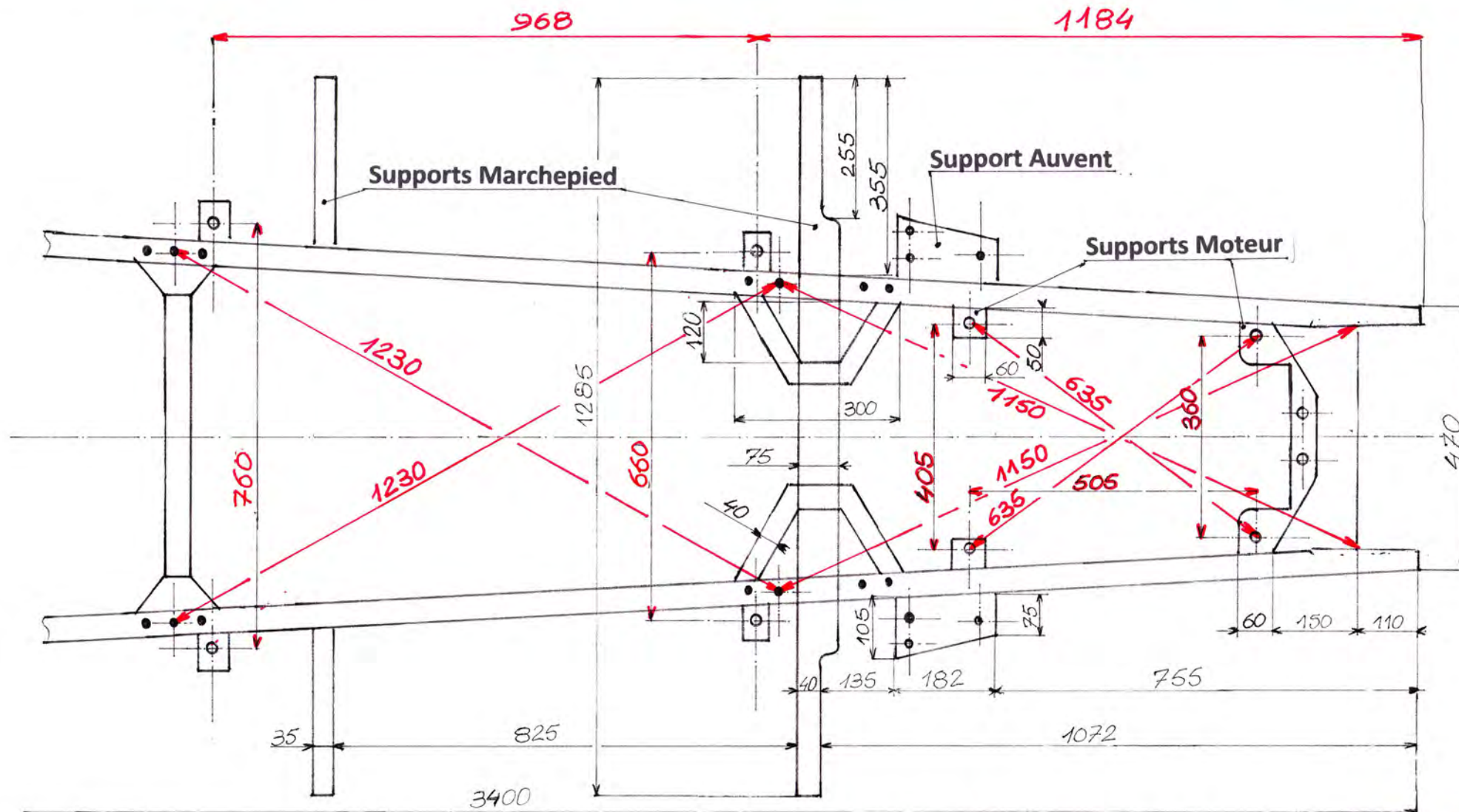

Châssis vue de côté AR	4 / 4
Châssis vue de côté AV	3 / 4
Châssis vue de dessus AR	2 / 4
Châssis vue de dessus AV	1 / 4
Désignation	Planche



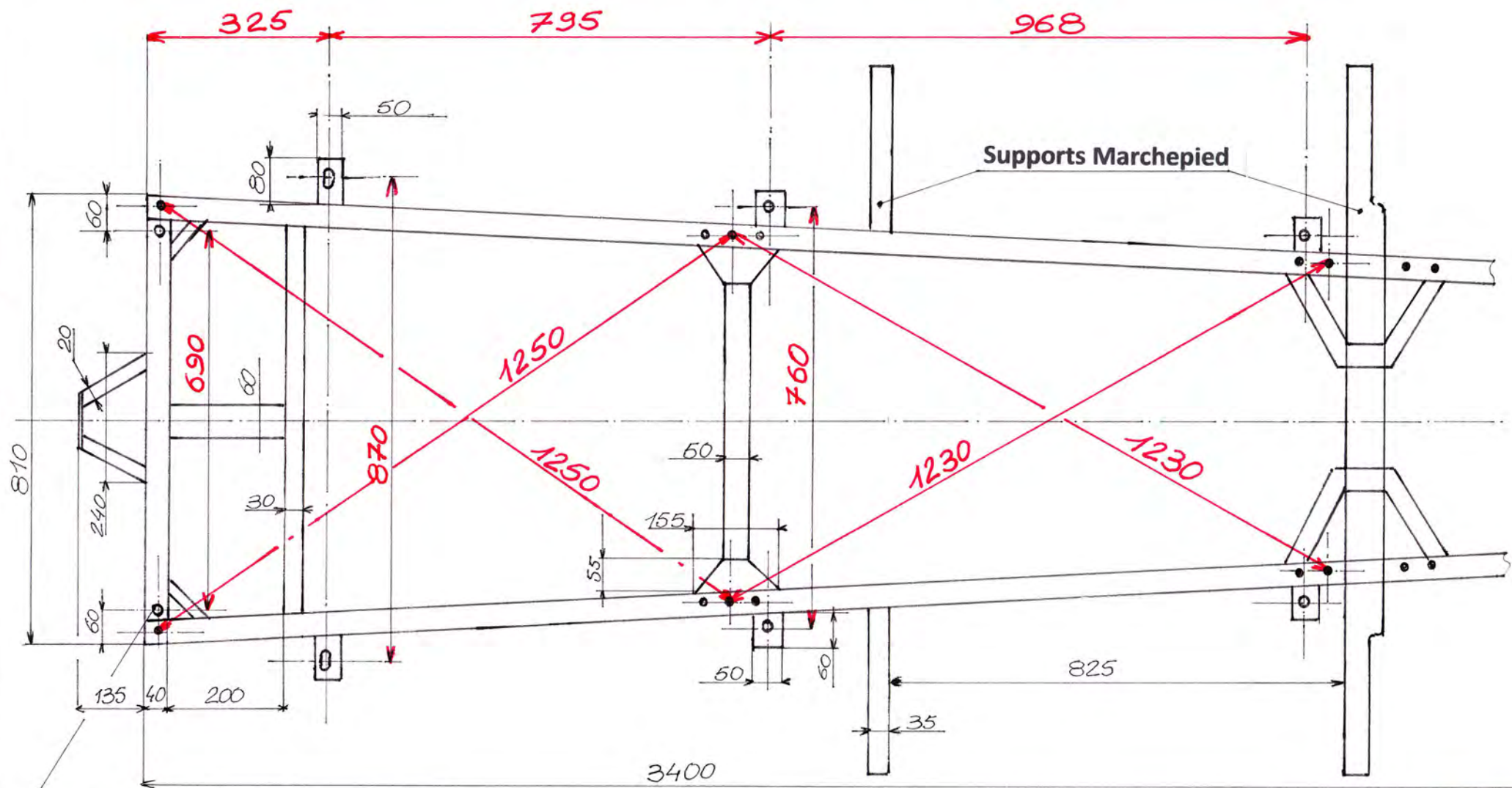

Echelle : 1/10	Châssis PEUGEOT 201	
Matière : Acier	<h1>Châssis</h1>	Octobre 2020
		Vue de Dessus AV



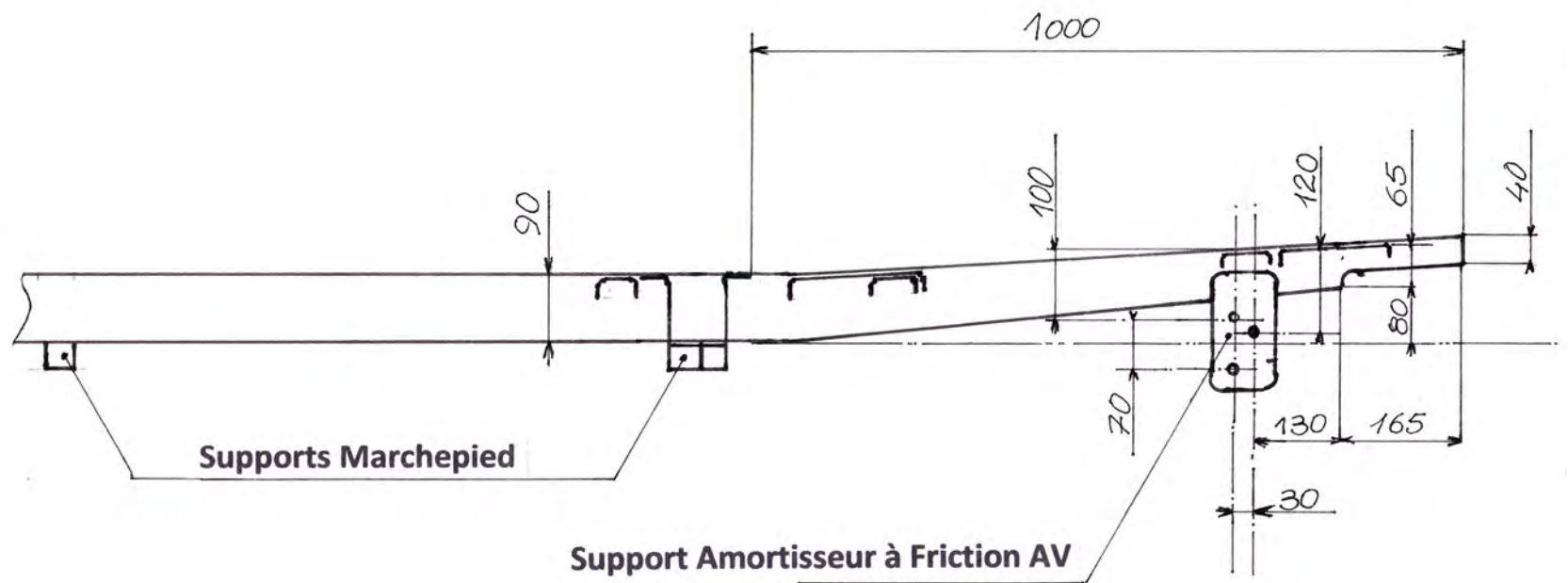

Trou Fixation Lames de suspension AR

<p>Echelle : 1/10</p>	<p>Châssis PEUGEOT 201</p>	
<p>Matière : Acier</p>	<p>Châssis</p>	<p>Octobre 2020</p>
		<p>Vue de Dessus AR</p>

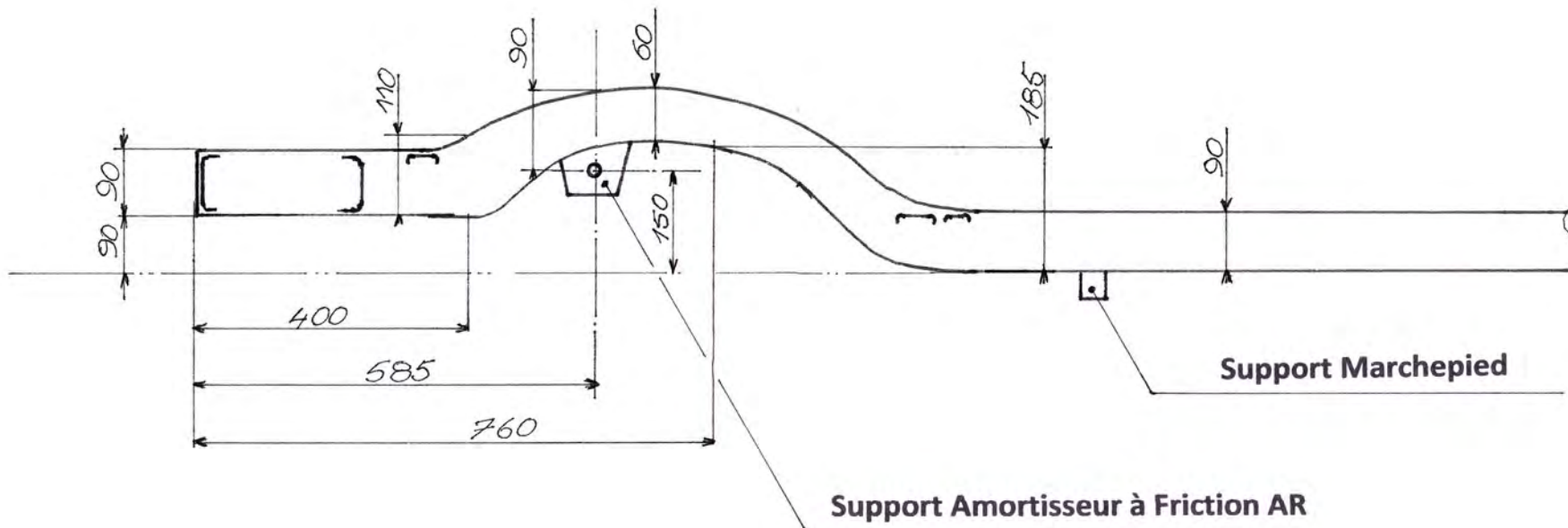

Echelle : 1/10	Châssis PEUGEOT 201	
Matière : Acier	Châssis Vue de coté AV	Octobre 2020
		Planche : 3/4



Echelle : 1/10	Châssis PEUGEOT 201	
Matière : Acier	Châssis Vue de coté AR	Octobre 2020
		Planche : 4/4