

P. GAYTON Rue Gambetta
03170 DOYET

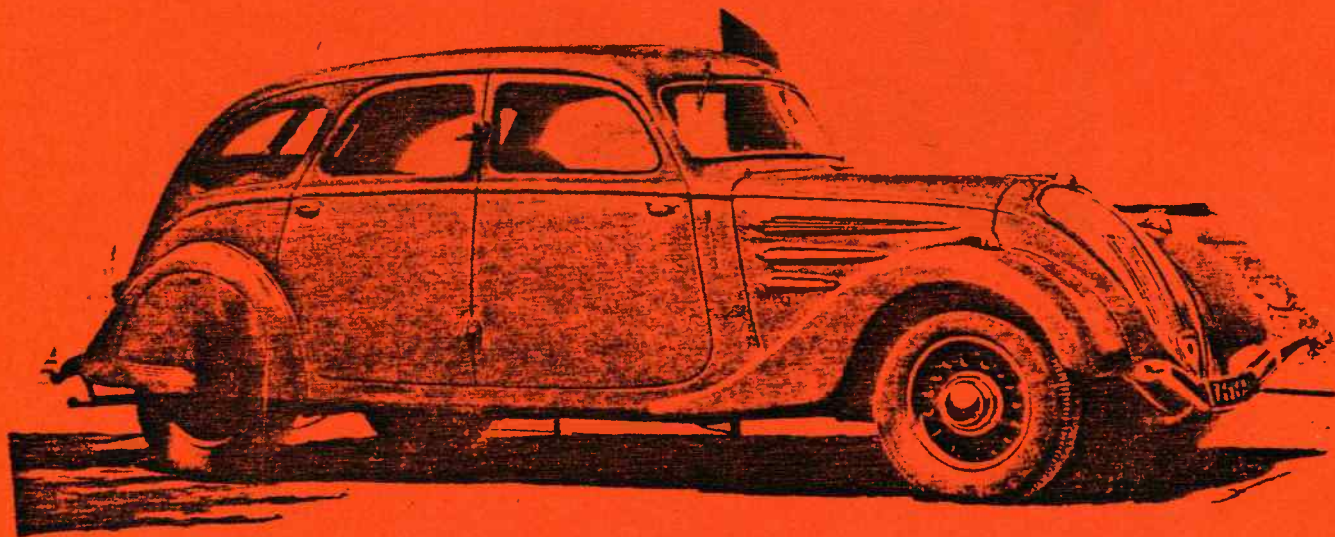
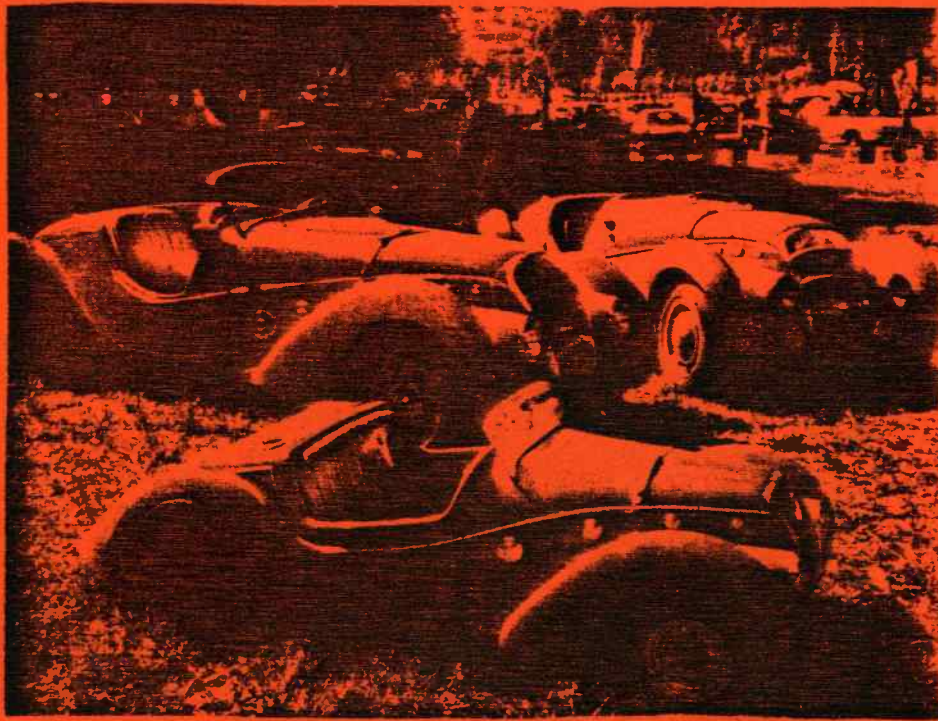

Echappements de Véhicules Anciens
Tél. 70.07.39.44

PEUGEOT_201B_201_201BR_201C

N° 20

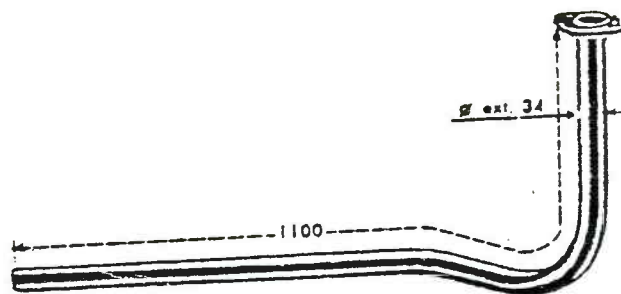

N° 10

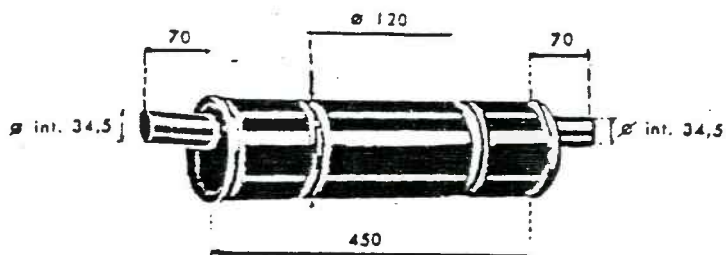

N° 30

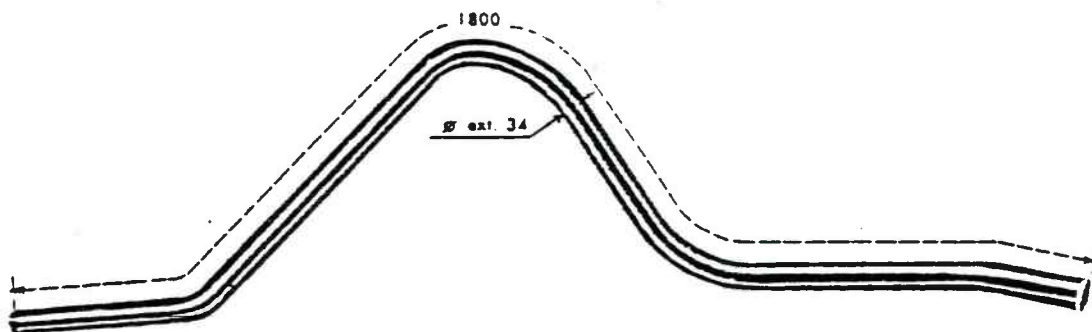

PEUGEOT_ 201T_ 201 SK

N° 20

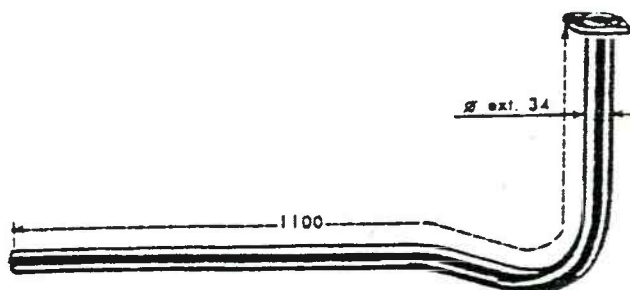

N° 40

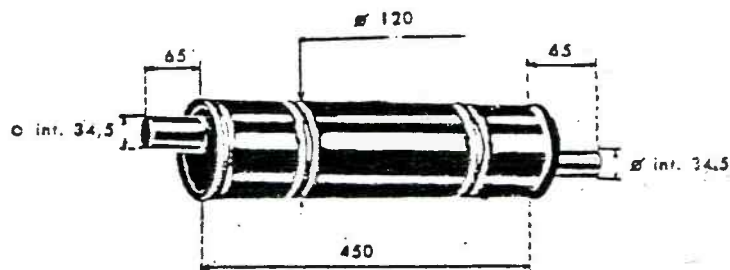

N° 50

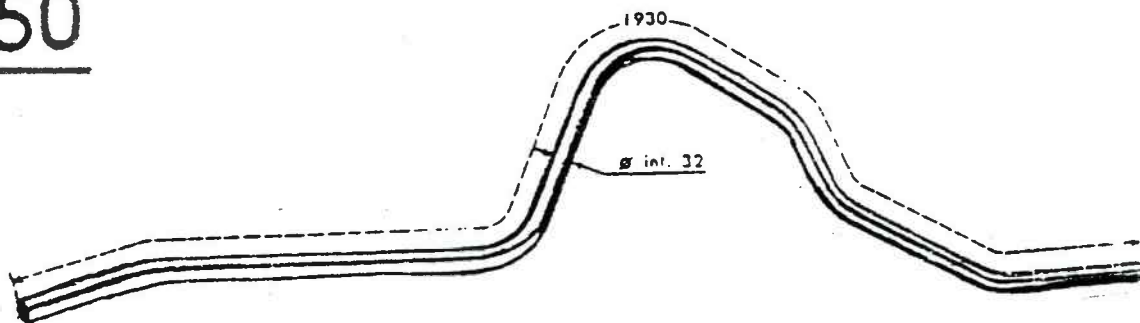

PEUGEOT_ 201D_ 201DL_ 201M

N° 60

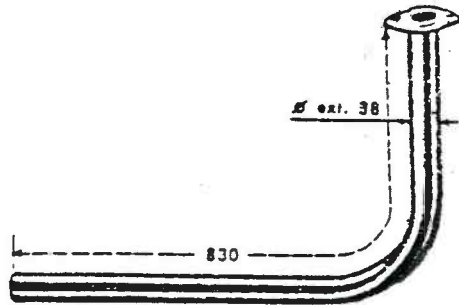

N° 70

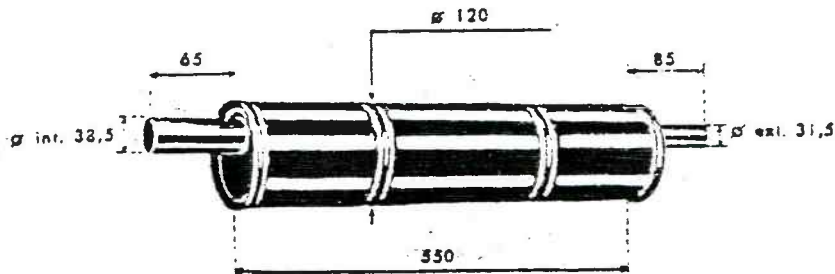

N° 80

Tube AR

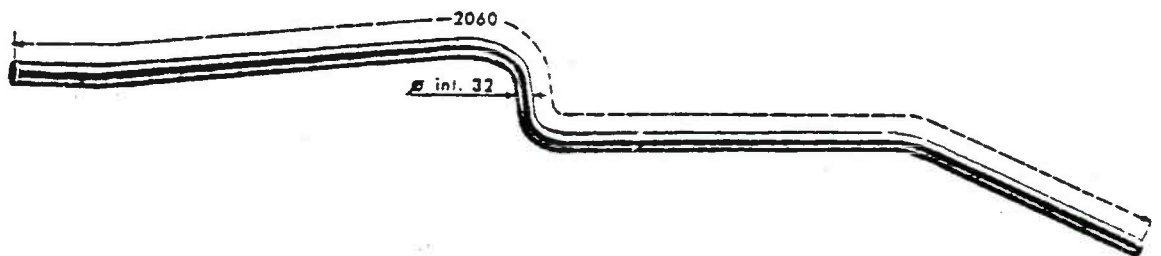

PEUGEOT 202 à barre de torsion

N° 90

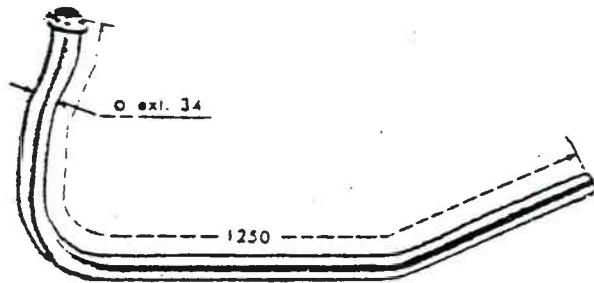

N° 100

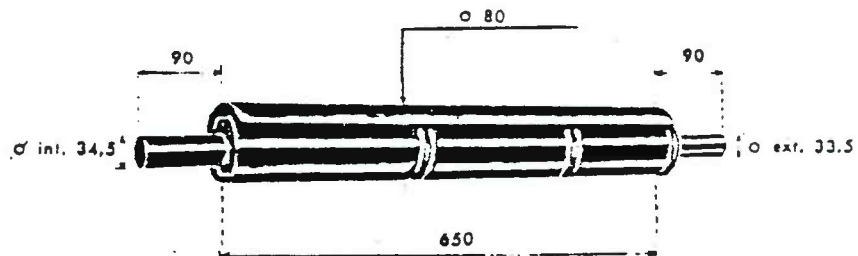

N° 110



PEUGEOT 202 B 202BH

(à ressort AV transversal)

N° 120

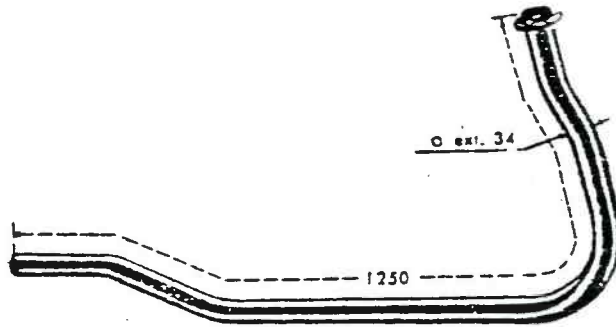

N° 130

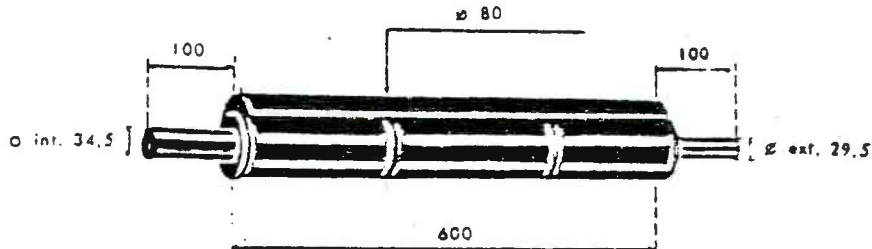

N° 140



PEUGEOT 202U.202UB.202UH

camionnettes 500 et 800 kgs

N° 120

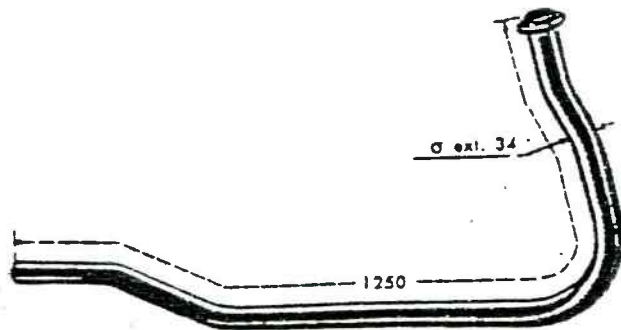

N° 130

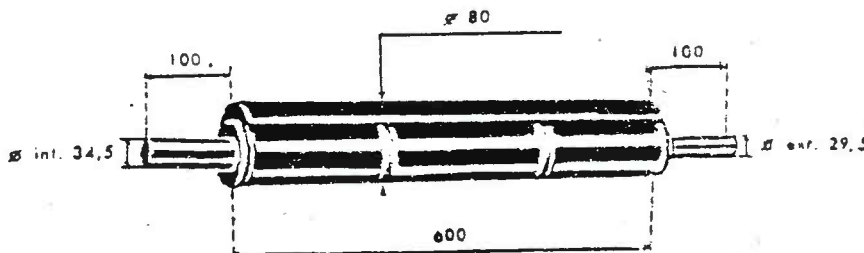

N° 370

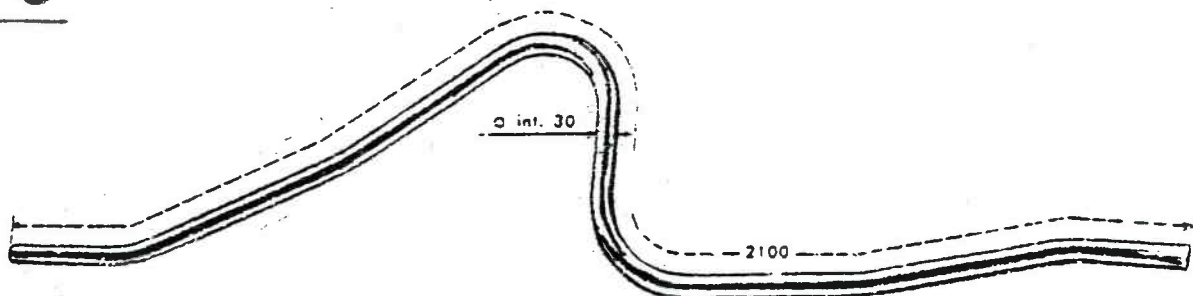

PEUGEOT 203 année 1949/51

N° 310

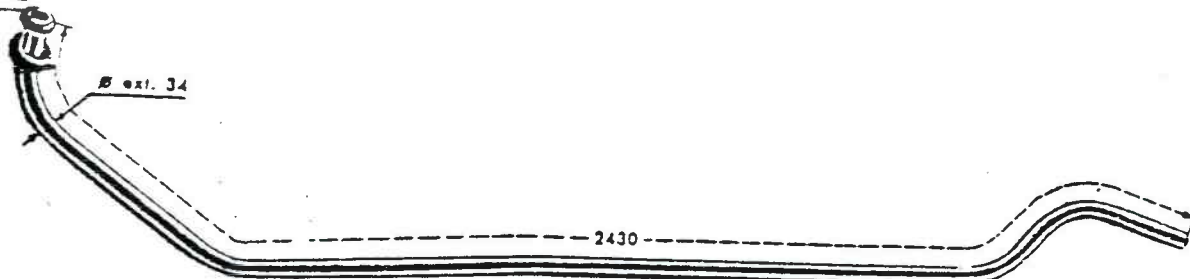

N° 320

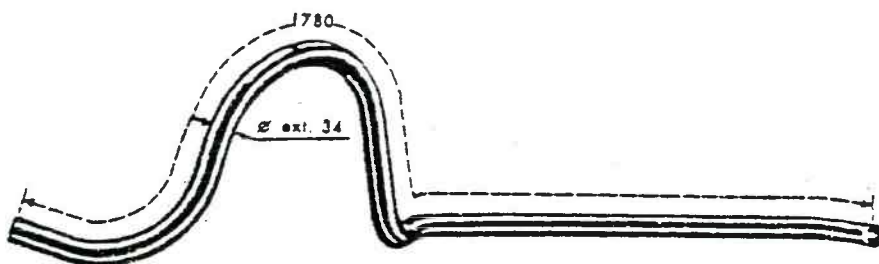

N° 330

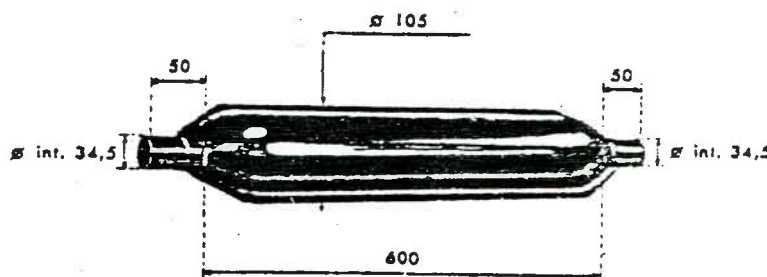

N° 340

Pipe de sortie silencieux

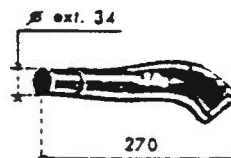

PEUGEOT 203 de 1952/53

203 C 1954/59

N° 350

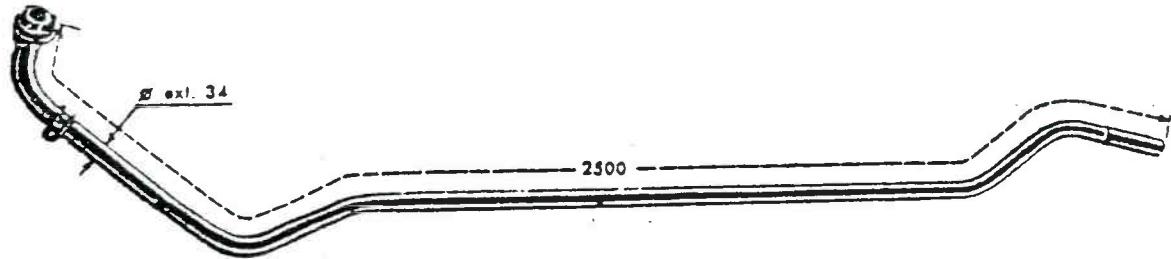

N° 360

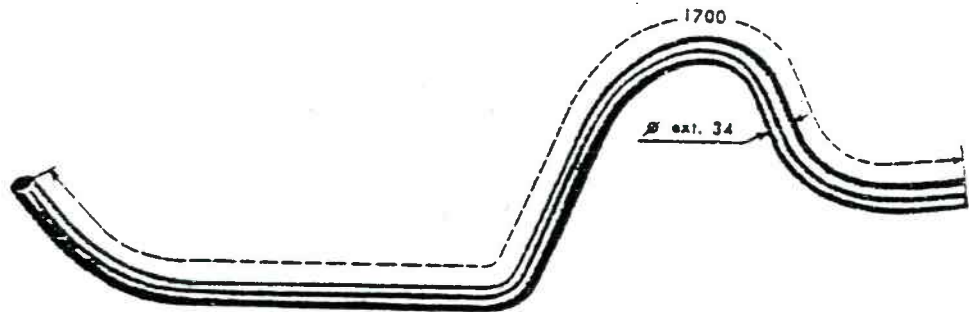

N° 330

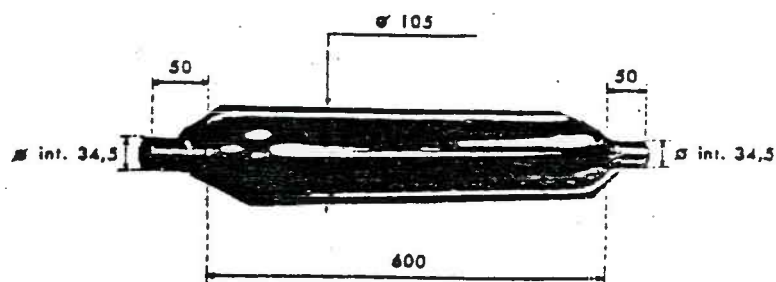

N° 340

Pipe de sortie silencieux.

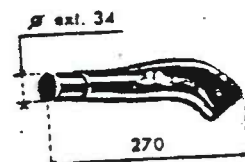

PEUGEOT 301_301C

N° 150

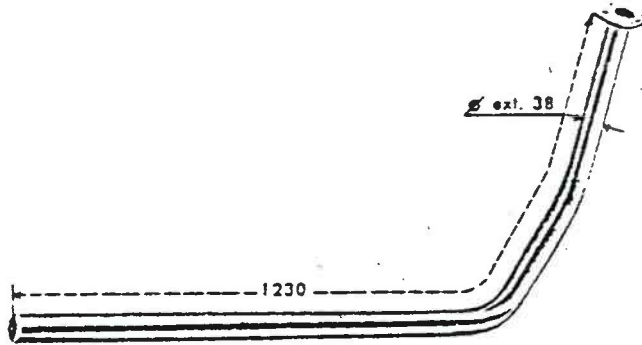

N° 70

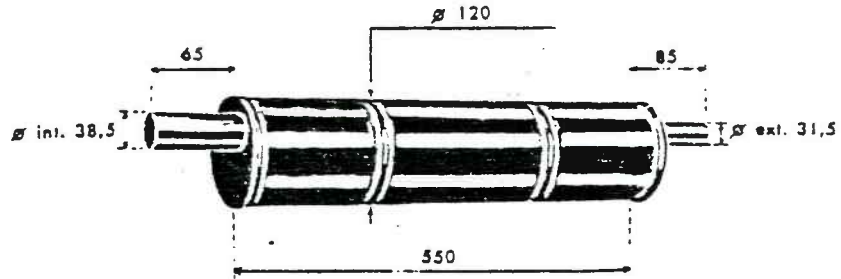

N° 160

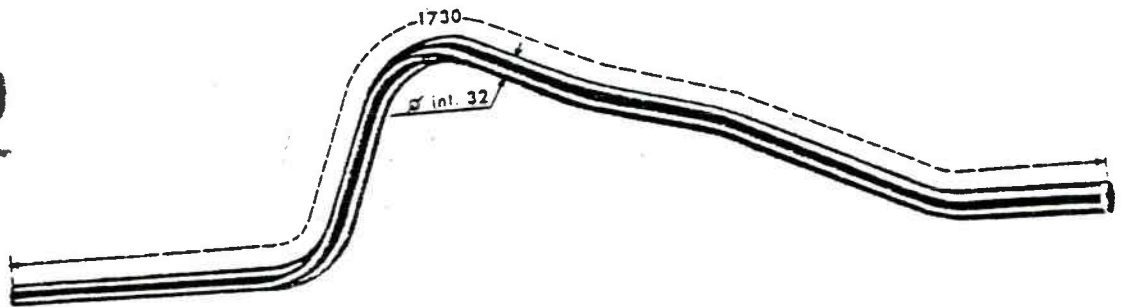

PEUGEOT 301 CR

N° 150

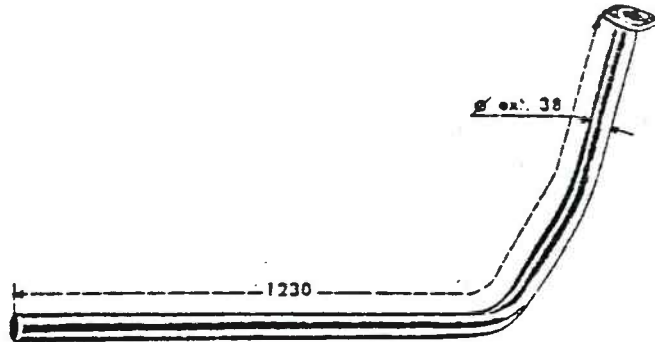

N° 70

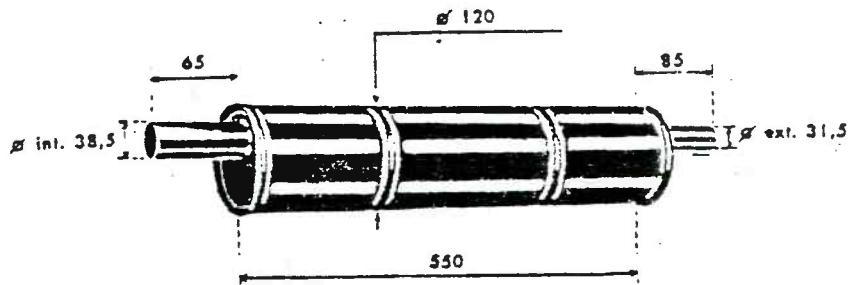

N° 170

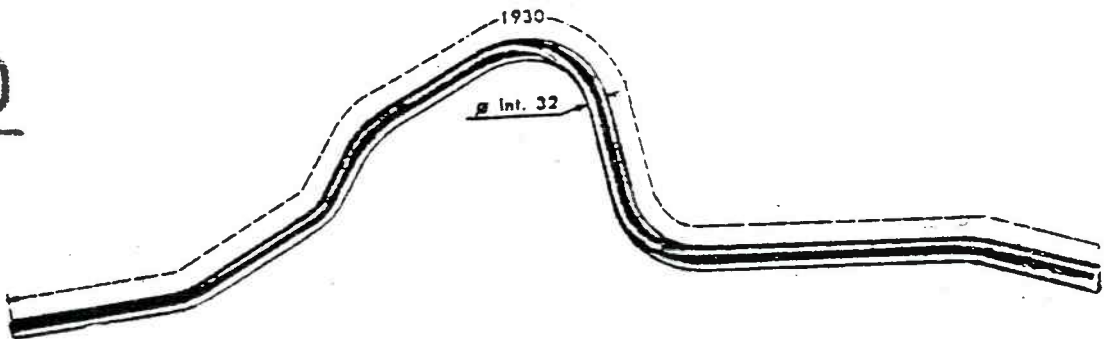

PEUGEOT 301 D

N° 60

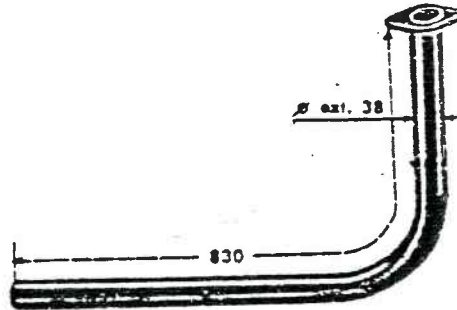

N° 70

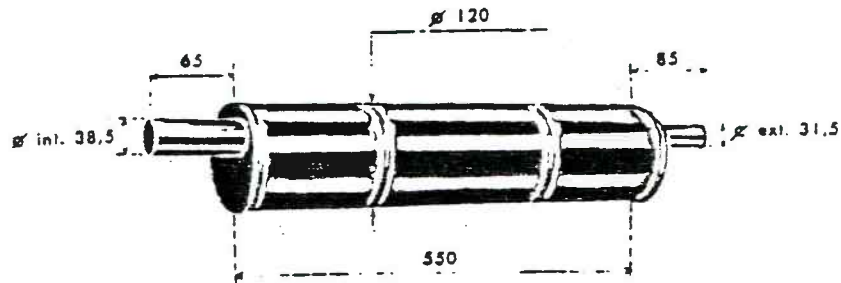

N° 80

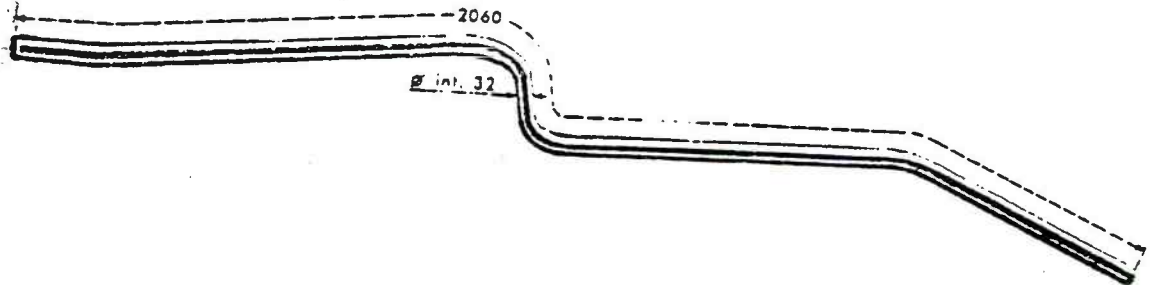

PEUGEOT 301 L

N° 180

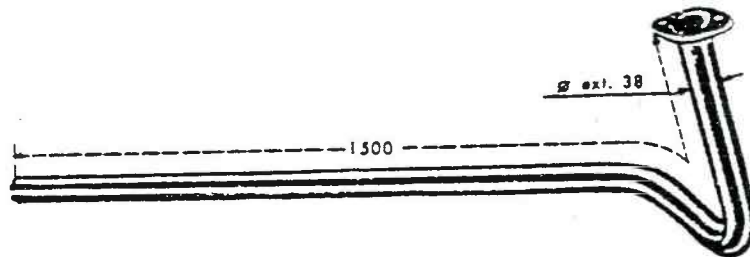

N° 70

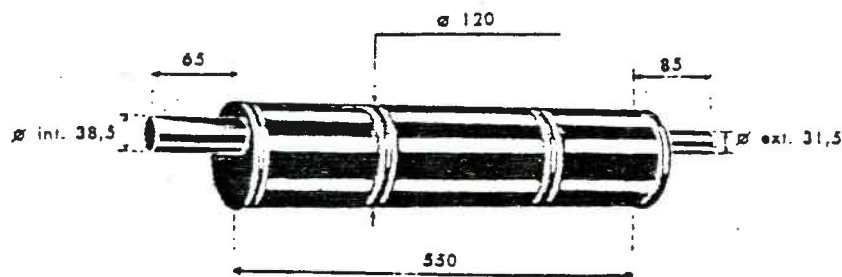

N° 190

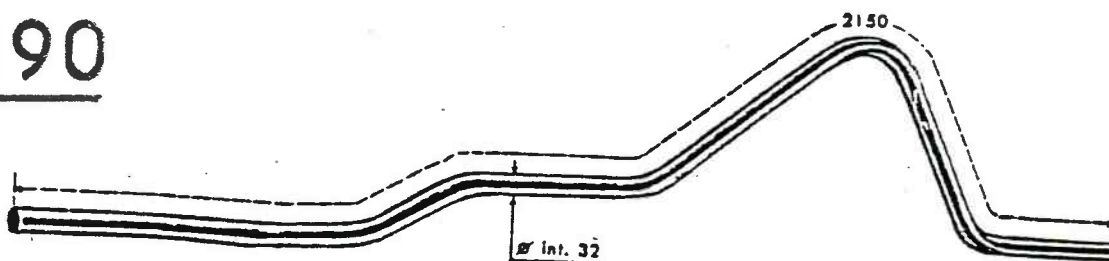

PEUGEOT 301 LR

N° 180

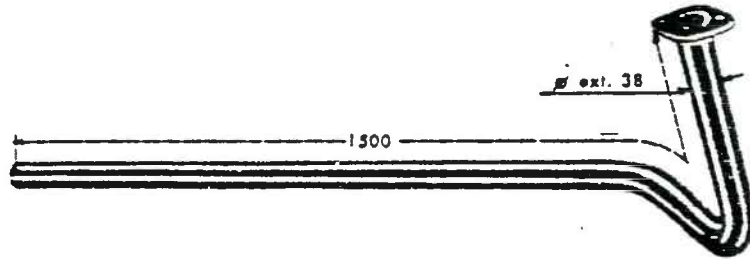

N° 70

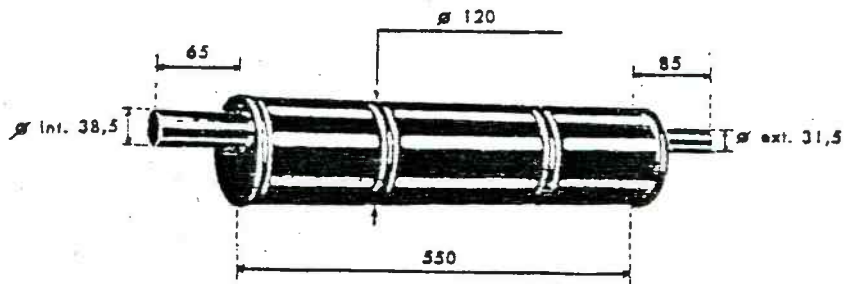

N° 50

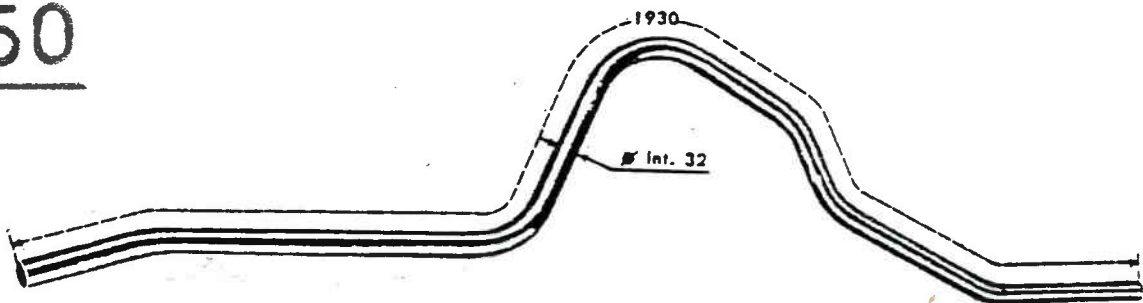

PEUGEOT 301T_301SKD

N° 200

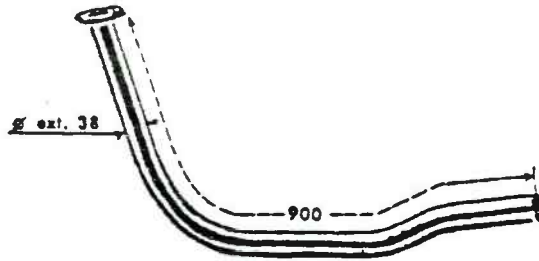

N° 70

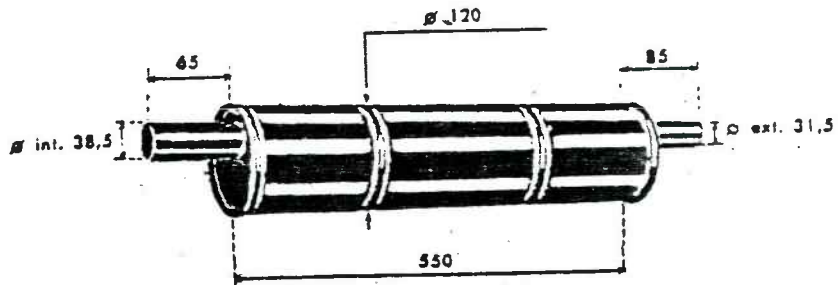

N° 190

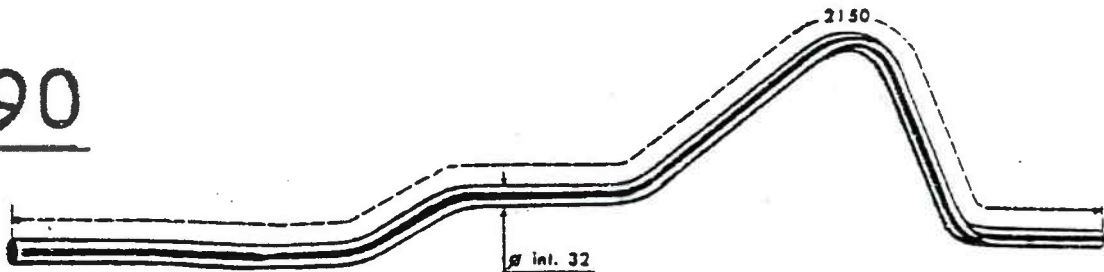

PEUGEOT 302

N° 210

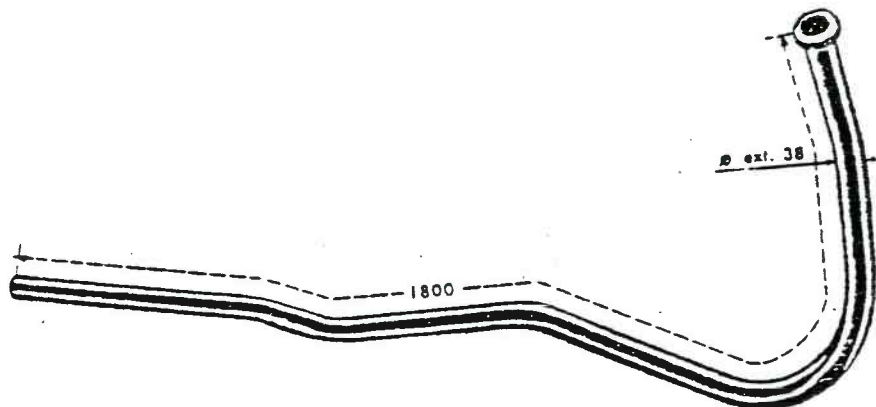

N° 220

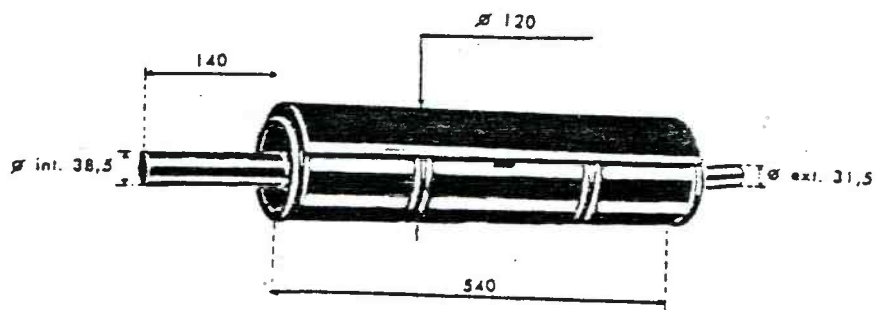

N° 230



PEUGEOT 401 D

N° 60

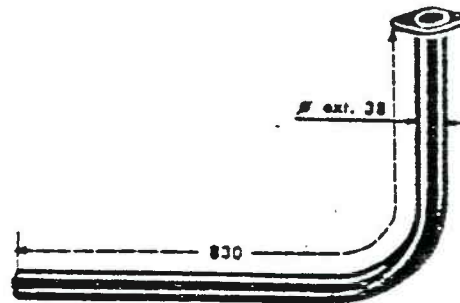

N° 240

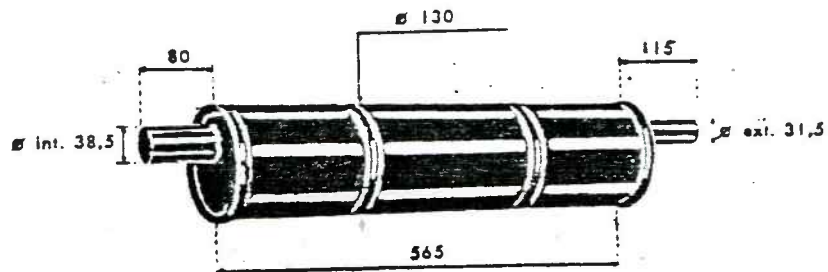

N° 250

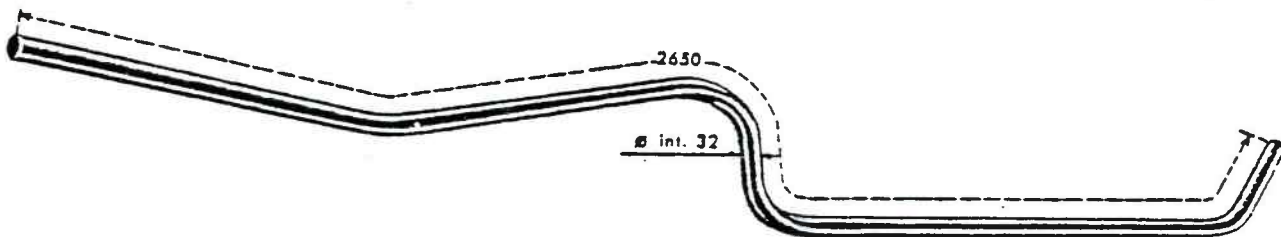

PEUGEOT 401DL.401DLT.401MKD

N° 200

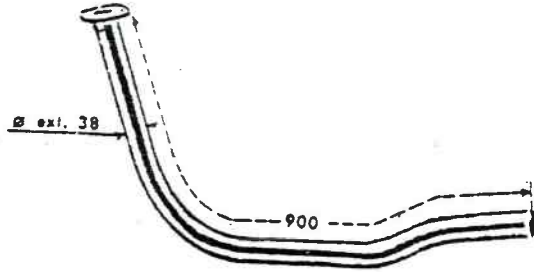

N° 240

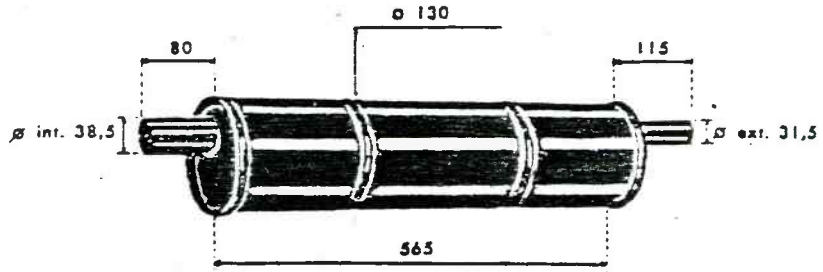

N° 250

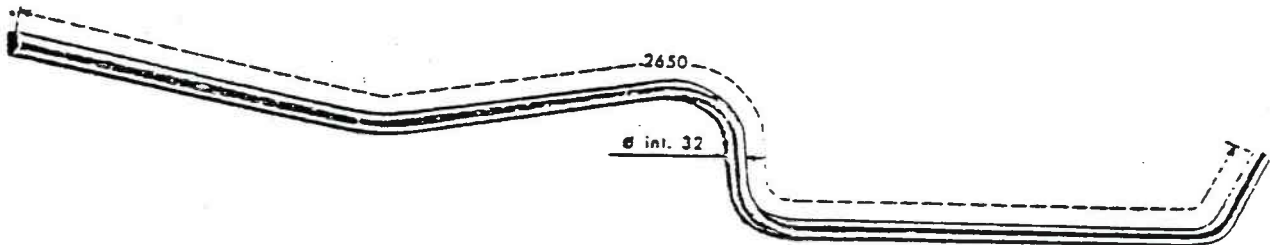

PEUGEOT 402 Légère

N° 260

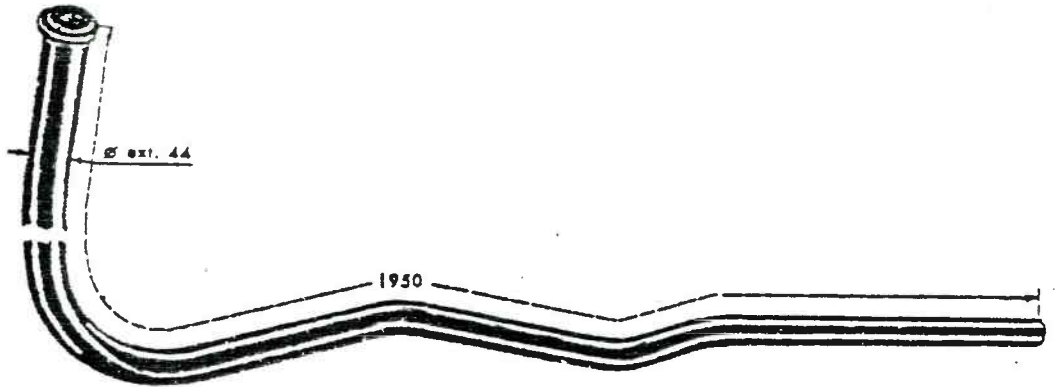

N° 270

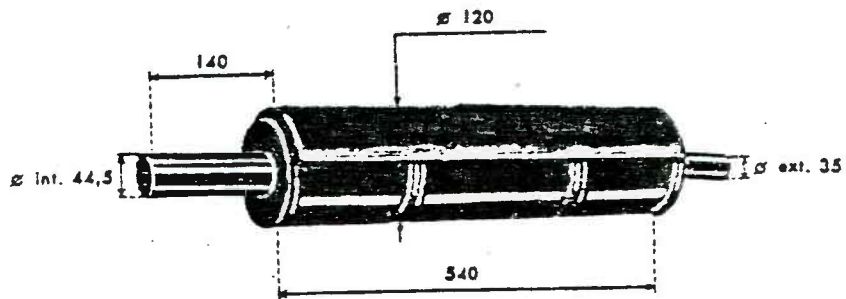

N° 280

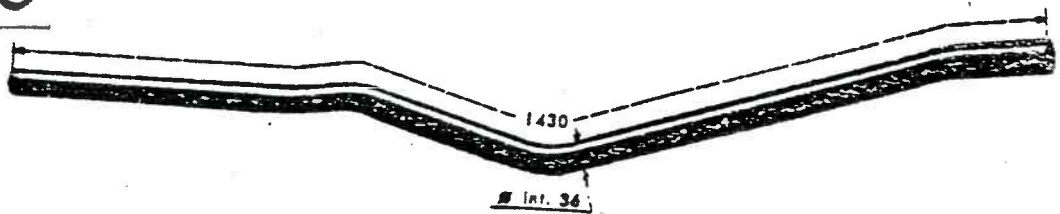

PEUGEOT 402 normale 402 familiale

N° 260

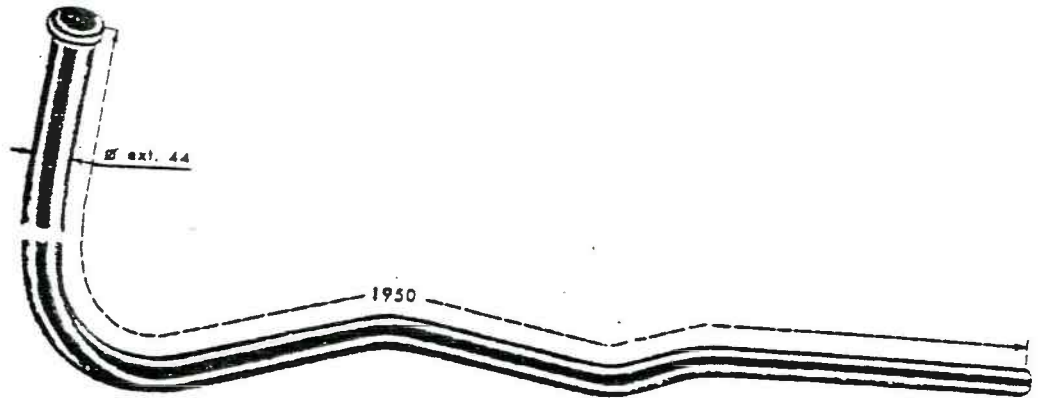

N° 290

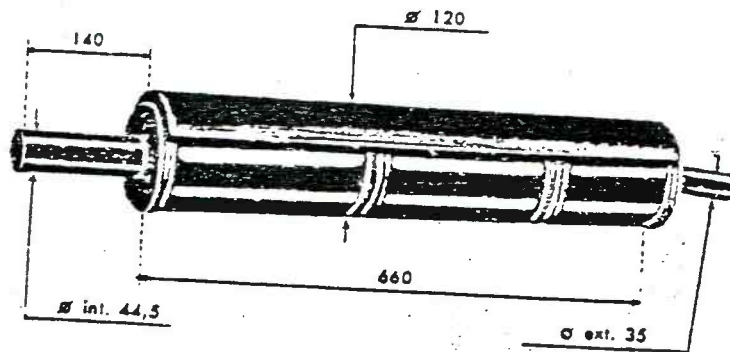

N° 300

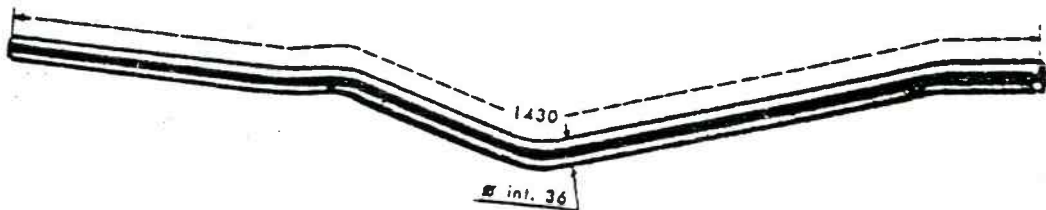

Prix des pieces pour 1993 + transport

Réf	Prix TTC	Poids
S 10	360.00 f	4 kgs
T 20	385.00 f	2 kgs
T 30	480.00 f	3 kgs
S 40	360.00 f	4 kgs
T 50	400.00 f	3 kgs
T 60	300.00 f	2 kgs
S 70	360.00 f	4 kgs
T 80	480.00 f	3 kgs
T 90	385.00 f	2 kgs
S 100	500.00 f	4.5 kgs
T 110	325.00 f	3 kgs
T 120	360.00 f	3 kgs
S 130	400.00 f	4.5 kgs
T 140	300.00 f	2.5 kgs
T 150	350.00 f	2.5 kgs
T 160	400.00 f	3 kgs
T 170	400.00 f	3.5 kgs
T 180	400.00 f	2.5 kgs
T 190	500.00 f	3.5 kgs
T 200	350.00 f	2 kgs
T 210	300.00 f	4 kgs
S 220	500.00 f	4.5 kgs
T 230	300.00 f	3 kgs
S 240	360.00 f	4 kgs
T 250	500.00 f	3.5 kgs
T 260	520.00 f	4 kgs
S 270	580.00 f	4.5 kgs
T 280	250.00 f	3 kgs
S 290	600.00 f	5 kgs
T 300	300.00 f	3 kgs
T 310	300.00 f	2 kgs
T 320	250.00 f	1.5 kgs
S 330	235.00 f	4 kgs
T 340	120.00 f	2 kgs
T 350	300.00 f	2 kgs
T 360	150.00 f	1.5 kgs
T 370	400.00 f	3.5 kgs

Prix du transport

0 à 10 kgs	180.00 f
11 à 20 kgs	220.00 f
21 à 30 kgs	280.00 f
31 à 40 kgs	320.00 f
41 à 50 kgs	340.00 f
51 à 60 kgs	365.00 f
61 à 70 kgs	395.00 f
71 à 80 kgs	420.00 f
81 à 90 kgs	445.00 f
91 à 100 kgs	475.00 f

